

HIGH SECURITY WINDOW LOCKS

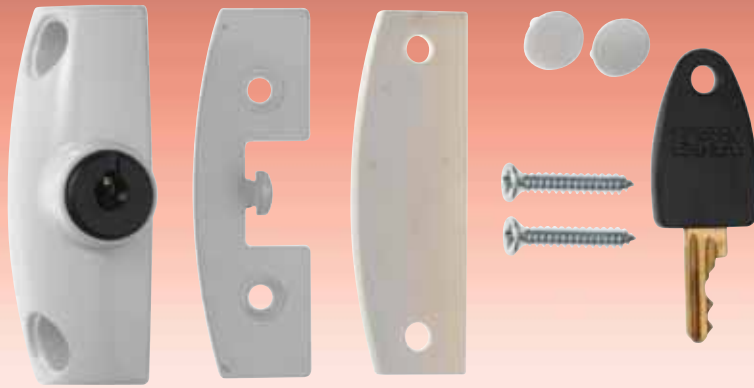

SNAPLOCK FOR WOODEN WINDOWS - CUT KEY VERSION

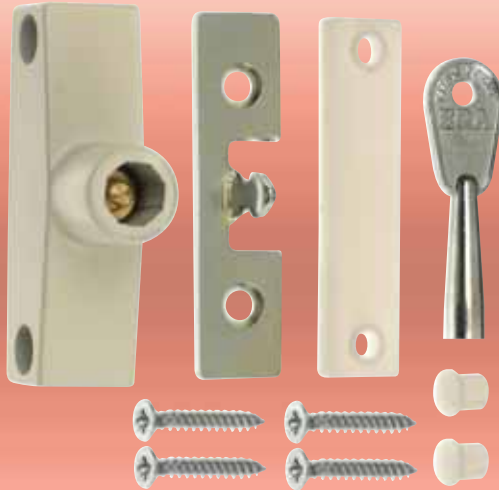

SNAPLOCK FOR WOODEN WINDOWS - STANDARD KEY VERSION

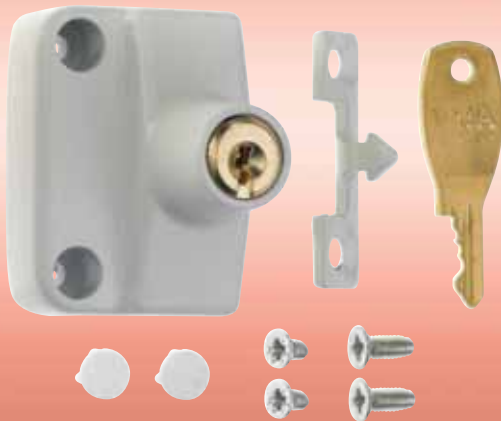

SNAPLOCK FOR METAL WINDOWS

The **ERA Snaplock** can be used on most types of windows including casement, side hung or top hung. Closing the window locks the Snaplock automatically - the key is only required to unlock.

Available for both wooden and metal frames and in a variety of finishes.

The mechanism is designed to allow for any subsequent movement of the window frame. Plugs conceal and protect the fixing screws.

Manufactured from coated steel, ERA Snaplocks are designed to withstand years of use.

Cut keyed versions of the snaplock can be supplied with keys to pass.

ORDERING DETAILS

Snaplock Wooden Windows - Standard Keys

White	801-12
Brown	801-22
Brassed	801-32
Saver Pack White - 4 per card	801-13
Saver Pack Brown - 4 per card	801-23
Saver Pack Brassed - 4 per card	801-33
Spare Standard key for Snaplock	581-56
2 Spare Standard keys - carded	581-52

Snaplock Wooden Windows - Cut Keys

White	2802-12
Brown	2802-22
Brassed	2802-32
Spare cut key for Snaplock	591-56
Key blank for Snaplock	682-56

Snaplock Metal Windows - Cut Key

White	904-12
-------	---------------

Snaplock for Wooden Windows - Cut Key

Snaplock for Wooden Windows - Standard

Snaplock - Metal Windows

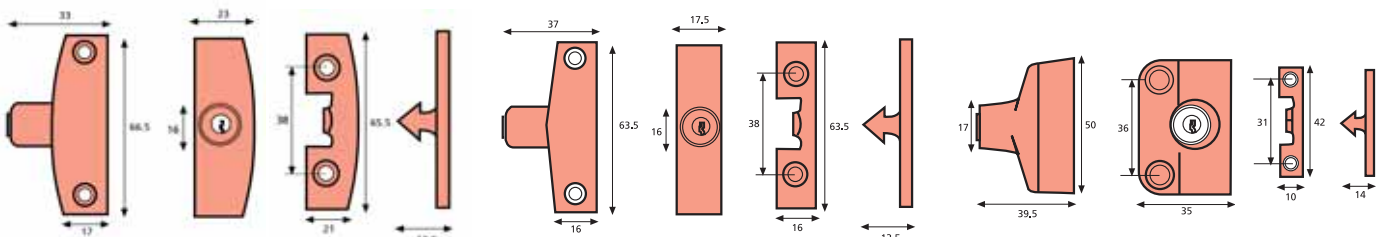

All dimensions in mm.

HIGH SECURITY WINDOW LOCKS

The **ERA Swinglock** is suitable for most wooden casement windows. The lock pivots to latch when the window is closed. The fixing screws are concealed when in the locked position. The locking action pulls the window tight into the frame, thus reducing drafts.

The **ERA Metal Swinglock** is suitable for most metal casement windows. The lock pivots to latch when the window is closed. The fixing screws are concealed when in the locked position. The locking action pulls the window tight into the frame, thus reducing drafts.

The **ERA Metal Window Lock** fits most metal windows including casement, side hung, pivot and top hung. The Metal Window Lock uses a cut key to lock and unlock. Fixing screws are self-tapping.

The **ERA Flush Pivot Lock** is suitable for most wooden windows, including casement, side hung, pivot, top hung and sliding. Each lock is supplied with a box keep in matching finish. The Flush Pivot Lock uses a cut key to lock and unlock. The hardened steel bolt is deadlocked in the box keep. Fitting is by thief-deterrent clutch-head screws.

ORDERING DETAILS

Swinglock Wooden Window – Standard Key

White **2809-12**

Swinglock Metal Window – Standard Key

White – 2 per card **2903-12**

Metal Window Lock – Cut Key

White **2901-12**

Spare Key for Metal Window Lock

Cut key **591-56**

Blank key **682-56**

Flush Pivot Lock – Cut Key

White **2902-12**

Brassed **2902-32**



SWINGLOCK FOR WOODEN WINDOWS



SWINGLOCK FOR METAL WINDOWS



METAL WINDOW LOCK

FLUSH PIVOT LOCK

Swinglock

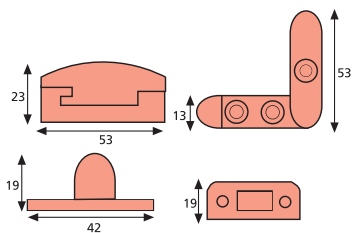

Metal Window Lock

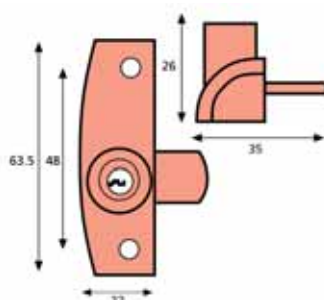

Flush Pivot Lock

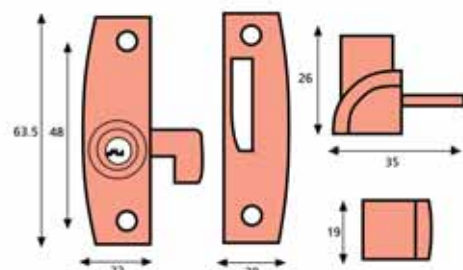

All dimensions in mm.

HIGH SECURITY WINDOW LOCKS



DUAL SCREWS

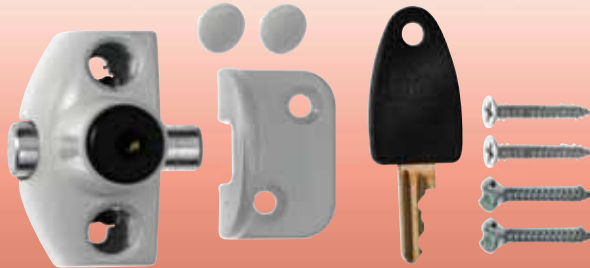

WINDOW BOLT - CUT KEY VERSION

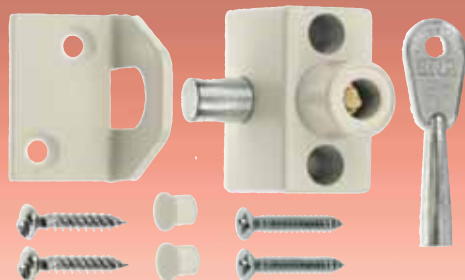

WINDOW BOLT - STANDARD KEY VERSION

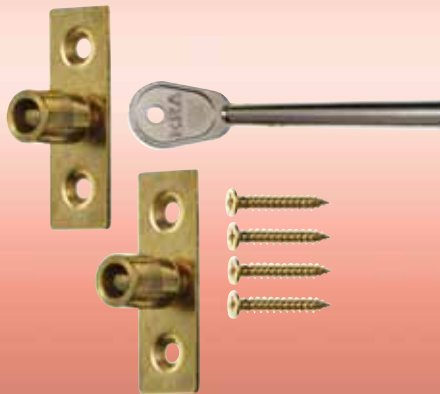

SASH LOCK

The **ERA Dual Screw** fits most sash windows and is concealed when fitted, offering added security. The lock uses a key operated locking pin in brass bushes.

The **ERA Window Bolt** is suitable for most types of wooden windows including casement, side hung, top hung and sash windows. Simply press the spring bolt to lock and use the key to unlock. A choice of finishes are available. Plugs conceal and protect the fixing screws. The rotating steel bolt resists hacksawing. The ERA Window Bolt is available with either a cut or standard key.

The **ERA Sash Lock** fits most sash windows. Constructed of steel, it provides a locking window stop which secures the window in the closed position using a standard key.

ORDERING DETAILS

Dual Screw - Standard Key

Brass - 2 per card	826-32
Brass - 6 per card	826-33
Spare key for Dual Screw	584-56

Sash Bolt - Cut Key

White	2804-12
Brown	2804-22
Brassed	2804-32

Sash Bolt - Standard Key

White	803-12
Brown	803-22

Window Bolt/Sash Bolt - Cut Key

White	854-12
Brown	854-22
Brassed	854-32

Window Bolt/Sash Bolt - Standard Key

White	853-12
Brown	853-22

Sash Lock - Standard Key

Brass - 2 per card	822-32
Satin - 2 per card	822-52
Spare key for Sash Lock	582-56

Dual Screw

Window Bolt - Key Cut

Window Bolt - Standard Key

Sash Lock

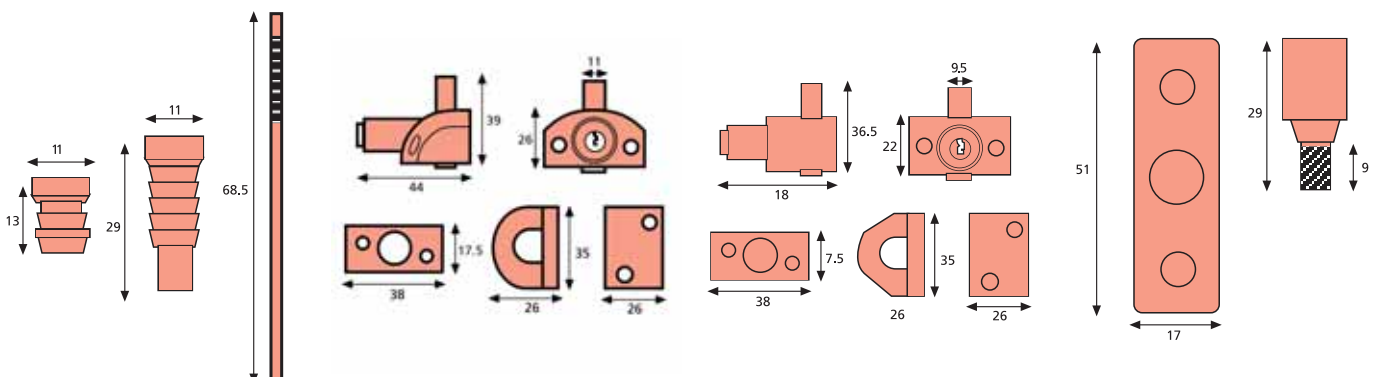

All dimensions in mm.

LOCKING HANDLES

The **ERA 808 Locking Handle** fits most wooden casement windows. It is self-locking, needing the cut key only to unlock. The mechanism allows fully closed locking or partial opening for ventilation.

ORDERING DETAILS

Cut Key

White **808-12**

Brassed **808-32**

Spare Keys for 808 Locking Handle

Cut Key **591-56**

Key Blank **682-56**



808 Locking Handle

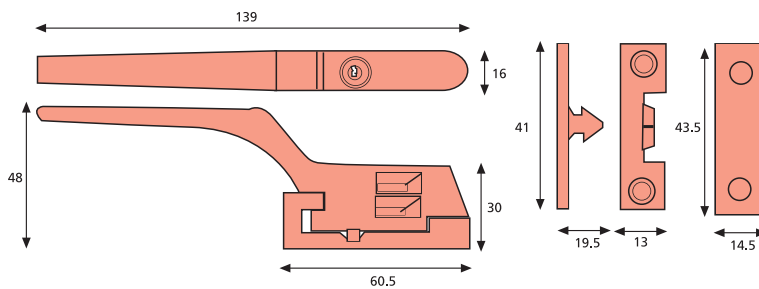

All dimensions in mm.

SECURISTAY

The **ERA Securistay** is designed specifically with child safety in mind. The Securistay restricts window opening to 75mm (3"). It is manufactured from high tensile aluminium and is available in two finishes. A special key is used to unlock and the lock can only be disconnected when the window is closed.

The Securistay is ideal for high rise buildings as it allows ventilation with safety. It is available for both wooden and metal framed windows.

ORDERING DETAILS

Securistay - Wooden Windows

White	720-12
Silver	720-72

Securistay - Metal Windows

White	721-12
Grey	721-72

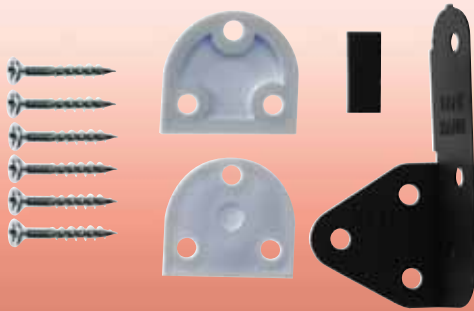
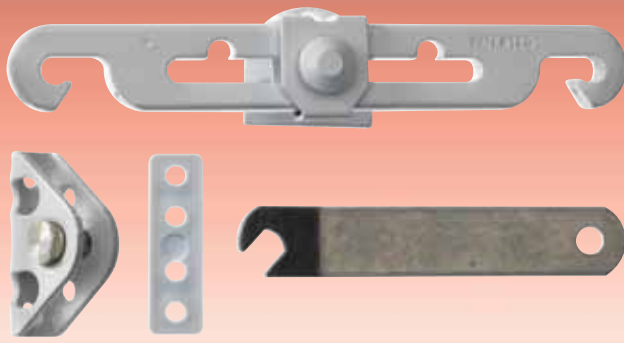

SECURISTAY - WOODEN WINDOWS

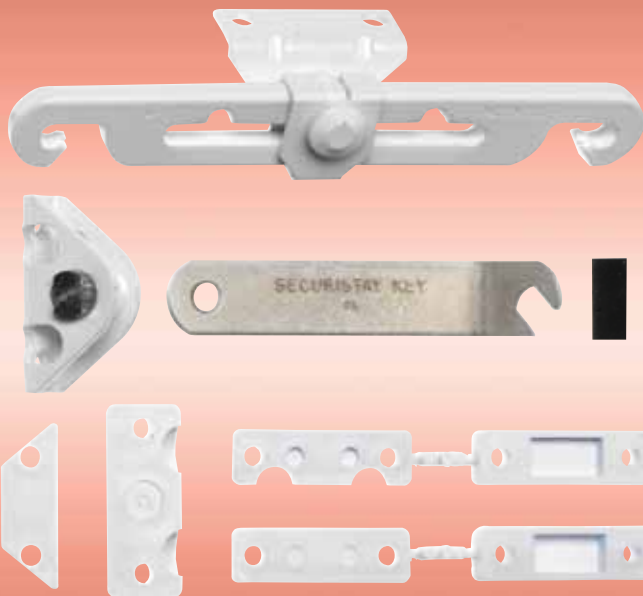

SECURISTAY - METAL WINDOWS

Securistay

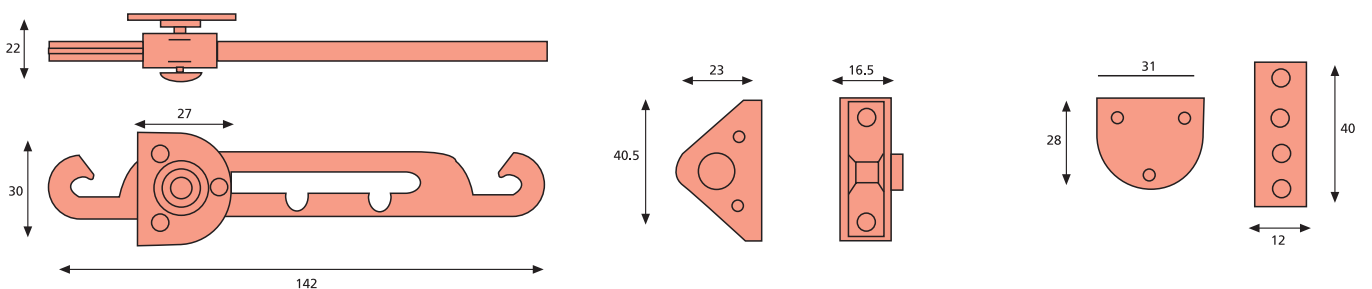

All dimensions in mm.